

Life Path 1



SPECIFICATIONS:

Housing:

Die-cast aluminum door & housing. Suitable for J-Box mounting or conduit entry.

Lens:

Polycarbonate lens.

Reflector:

Specular aluminum reflector.

Rechargeable Battery:

6V 5Ah Nickel Cadmium Rechargeable battery. 90 minute illumination, then recharge in 24 hours. Limited 5 year warranty.

Finish:

Attractive dark bronze, white, polyester powder coated finish for excellent impact, corrosion and UV resistance

Emergency Lighting Unit

Job Information

Project:	Date:
Location:	
Fixture Type:	Cat. #
Lamp:	Volts:
Options & Accessories:	

DIMENSIONAL DRAWINGS

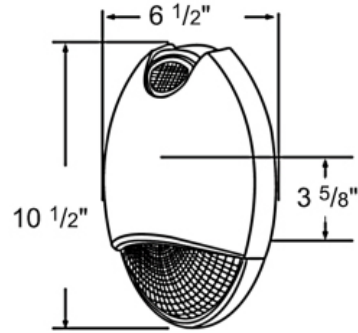

Tall	Width	Depth	MH	Xenon	EPA	Weight
10.50"	6.50"	5.50"	—	2 x 6w	—	8 lbs.

ORDERING INFORMATION:

Model	Optics	Wattage	Source	Voltage	Mounting	Finish	Options
<ul style="list-style-type: none"> LPH 1 	Flood Wide <ul style="list-style-type: none"> (FW) 	6 watts <ul style="list-style-type: none"> (2x6) 	Xenon <ul style="list-style-type: none"> (X) 	120/277 Electronic Dual Volts <ul style="list-style-type: none"> (DV) 	Wall Mount <ul style="list-style-type: none"> (WM) 	Bronze <ul style="list-style-type: none"> (BZ) White <ul style="list-style-type: none"> (WT) Custom Color <ul style="list-style-type: none"> (CC) Custom Color Consult Facoty 	No options

Direct Lighting Sales reserves the right to make modifications or changes to any of its products without prior written notification and without incurring obligation. Actual performance can vary depending on surrounding conditions

SM019



SPECIFICATIONS:

Housing:

Heavy Die-Cast Aluminum housing with 1/2" threaded holes provided for surface conduit entry or optional photo cell. Door frame is Hinged for easy re-lamping complete with weather proof silicone seal.

Lens:

Clear prismatic borosilicate glass refractor is thermal and shock Resistant.

Reflector:

Optical Quality white powder coat works in tandem with a light-diffusing borosilicate glass lens for optimum light distribution.

Ballast Assembly:

HID Ballast constant Wattage Auto-Transformer High Power Factor Core And coil Type, Rated -20 Degrees Fahrenheit Staring Temperature. Integrally Mounted in the Luminaire and Completely Prewired. Each Ballast Assembly Is Thoroughly Tested Prior To Shipment. Ballast and Electrical Components Are "UL" Listed.

Lamp Socket:

Porcelain Socket pulse rated for HPS, MH & PS lamps. Lamp included.

Finish:

Electro-Static Powder Coat Bronze & White, contact factory for custom colors.

Job Information

Project: _____ Date: _____

Location: _____

Fixture Type: _____ Cat. # _____

Lamp: _____ Volts: _____

Options & Accessories: _____

DIMENSIONAL DRAWINGS

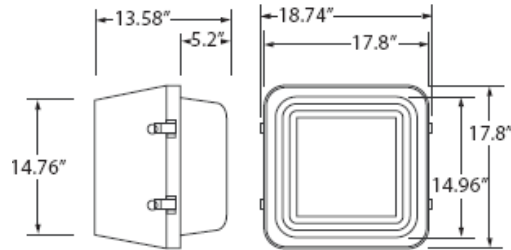

Height	Width	Length	MH	PS	HPS	Weight
13.58"	17.8"	17.8"	400	400	400	18 lbs.

Isolux Curves

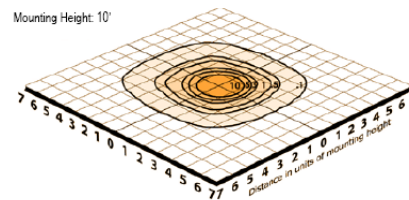

400w MH
@ 10-Ft.
Mounting
Height

ORDERING INFORMATION:

Model	Optics	Wattage	Source	Voltage	Wiring	Finish	Options
<ul style="list-style-type: none"> SM019 	Borosilicate Glass <ul style="list-style-type: none"> (BG) 	175w <ul style="list-style-type: none"> (175) 250w <ul style="list-style-type: none"> (250) 320w <ul style="list-style-type: none"> (320) 400w <ul style="list-style-type: none"> (400) 	High Pressure Sodium <ul style="list-style-type: none"> (HPS) Metal Halide <ul style="list-style-type: none"> (MH) Pulse Start Metal Halide <ul style="list-style-type: none"> (PS) 	120 Volts <ul style="list-style-type: none"> (120) 208 Volts <ul style="list-style-type: none"> (208) 240 Volts <ul style="list-style-type: none"> (240) 277 Volts <ul style="list-style-type: none"> (277) 480 Volts <ul style="list-style-type: none"> (480) Multi-Tap Ballast Factory wired at 277v unless otherwise specified.	Ceiling Mount <ul style="list-style-type: none"> (CM) 	Bronze <ul style="list-style-type: none"> (BZ) White <ul style="list-style-type: none"> (WT) Custom Color <ul style="list-style-type: none"> (CC) Custom color consult with factory	Photo Cell 120 thru 277v <ul style="list-style-type: none"> (PC__) Single Fuse <ul style="list-style-type: none"> (SF) Double Fuse <ul style="list-style-type: none"> (DF) Quartz Re-Strike <ul style="list-style-type: none"> (QR)

Direct Lighting Sales reserves the right to make modifications or changes to any of its products without prior written notification and without incurring obligation. Actual performance can vary depending on surrounding conditions

SM302



SPECIFICATIONS:

Housing:

Die-cast aluminum door has two captive stainless steel fasteners and can be removed from the die-cast aluminum housing.

Lens:

Clear glass Lens, 1/8" tempered, gasket and silicone sealed

Reflector:

Segmented anodized specular aluminum reflector .

Ballast Assembly:

HID ballast is mounted to the frame of the housing, ballast is removable for easy maintenance.

Lamp Socket:

Porcelain socket pulse rated for HPS & MH lamps. lamp included.

Finish:

Attractive dark bronze, white, black polyester powder coated finish for excellent impact, corrosion and UV resistance

Job Information

Project:	Date:
Location:	
Fixture Type:	Cat. #
Lamp:	Volts:
Options & Accessories:	

DIMENSIONAL DRAWINGS

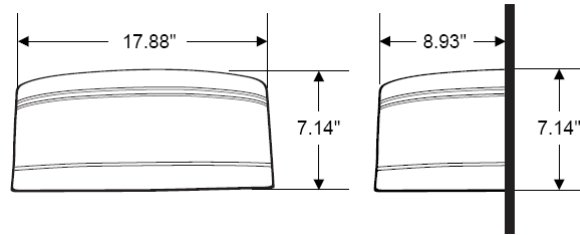

Height	Width	Depth	MH	HPS	EPA	Weight
7.14"	17.88"	8.93"	175	150		22 lbs.

Isolux Curves

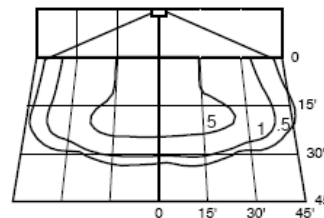

175 Watt
Metal halide
@ 15 Ft.
mounting
height

ORDERING INFORMATION:

Model	Optics	Wattage	Source	Voltage	Wiring	Finish	Options
<ul style="list-style-type: none"> SM302 	Forward Throw Wide <ul style="list-style-type: none"> (FTW) 	<ul style="list-style-type: none"> 35w (35) 50w (50) 70w (70) 100w (100) 150w (150) 175w (175) 	HPS <ul style="list-style-type: none"> (HPS) Metal Halide <ul style="list-style-type: none"> (MH) 	120 Volts <ul style="list-style-type: none"> (120) 208 Volts <ul style="list-style-type: none"> (208) 240 Volts <ul style="list-style-type: none"> (240) 277 Volts <ul style="list-style-type: none"> (277) 480 Volts <ul style="list-style-type: none"> (480) Multi-Tap Ballast Factory wired at 277 v unless otherwise speci- fied.	Wall Mount <ul style="list-style-type: none"> (WM) 	Bronze <ul style="list-style-type: none"> (BZ) White <ul style="list-style-type: none"> (WT) Black <ul style="list-style-type: none"> (BK) 	No lamp <ul style="list-style-type: none"> (NL) Photocell <ul style="list-style-type: none"> (PC)

Direct Lighting Sales reserves the right to make modifications or changes to any of its products without prior written notification and without incurring obligation. Actual performance can vary depending on surrounding conditions

VN41



SPECIFICATIONS:

Housing:

Durable corrosion-resistant, die-cast aluminum enclosure with an architectural bronze or white powder coat finish. Enclosure is fully sealed and gasketed, and is wet location listed for outdoor use and includes corrosion-resistant hardware. 1/2" NPT entry point for conduit entry.

Lens:

Vandal-resistant, UV stabilized polycarbonate prismatic refractor.

Reflector:

Internal anodized aluminum reflector which provides ideal light distribution

Ballast Assembly:

High quality electronic high power factor or reactor type ballast, dependant on the lamp type and wattage and 120v or 120 thru 277 volts multi-tap

Lamp Socket:

Glazed porcelain socket pulse rated for 4KV or universal 4 pin socket.

Finish:

Attractive dark bronze or white polyester powder coated finish for excellent impact, corrosion and UV resistance

Job Information

Project:	Date:
Location:	
Fixture Type:	Cat. #
Lamp:	Volts:
Options & Accessories:	

DIMENSIONAL DRAWINGS

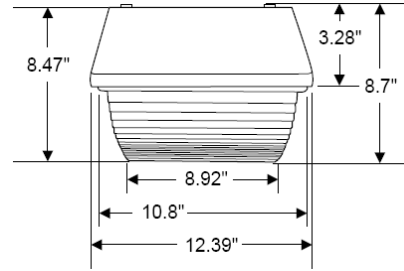

Height	Width	Length	MH	HPS	CFL	Weight
8.47"	12.39"	12.39"	150	150	2x42	18lbs.

Isolux Curves

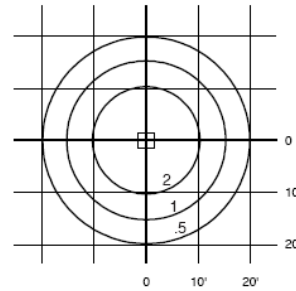

100 watt
Pulse Start
Metal Halide
Mounting
Height:
10'

ORDERING INFORMATION:

Model	Optics	Wattage	Source	Voltage	Wiring	Finish	Options
<ul style="list-style-type: none"> VN41 	Type V <ul style="list-style-type: none"> (T5) 	26w <ul style="list-style-type: none"> (26) 2x26w <ul style="list-style-type: none"> (2x26) 32w <ul style="list-style-type: none"> (32) 2x32w <ul style="list-style-type: none"> (2x32) 42w <ul style="list-style-type: none"> (42) 2x42w <ul style="list-style-type: none"> (2x42) 70w <ul style="list-style-type: none"> (70) 100w <ul style="list-style-type: none"> (100) 150w <ul style="list-style-type: none"> (150) 	HPS <ul style="list-style-type: none"> (HPS) Pulse Start Metal Halide <ul style="list-style-type: none"> (PS) Compact Fluorescent <ul style="list-style-type: none"> (CFL) 	120 Volts <ul style="list-style-type: none"> (120) 208 Volts <ul style="list-style-type: none"> (208) 240 Volts <ul style="list-style-type: none"> (240) 277 Volts <ul style="list-style-type: none"> (277) 480 Volts <ul style="list-style-type: none"> (480) Multi-Tap Ballast Factory wired at 277v unless otherwise specified.	Surface <ul style="list-style-type: none"> (SM) 	Bronze <ul style="list-style-type: none"> (BZ) White <ul style="list-style-type: none"> (WT) 	Photocell 120v <ul style="list-style-type: none"> (PC120) Photocell 208-277 <ul style="list-style-type: none"> (PC77) Quartz Restrike <ul style="list-style-type: none"> (QR150)

Direct Lighting Sales reserves the right to make modifications or changes to any of its products without prior written notification and without incurring obligation. Actual performance can vary depending on surrounding conditions

WP10



SPECIFICATIONS:

Housing:

Die-Cast Aluminum housing with Threaded Side Conduit Access, Photo Cell

Lens:

Prismatic Diffuser Wide Light Distribution

Reflector:

Specular aluminum reflector

Ballast Assembly:

HID Ballast constant Wattage Auto-Transformer High Power Factor Core and coil Type, Rated -20 Degrees Fahrenheit Staring Temperature. Integrally Mounted in the Luminaire and Completely Prewired. Each Ballast Assembly Is Thoroughly Tested Prior To Shipment. Ballast and Electrical Components Are "UL" Listed.

Lamp Socket:

Porcelain Socket pulse rated for HPS & MH lamps. Lamp included.

Finish:

Polycarbonate Bronze & White

Job Information

Project:	Date:
Location:	
Fixture Type:	Cat. #
Lamp:	Volts:
Options & Accessories:	

DIMENSIONAL DRAWINGS

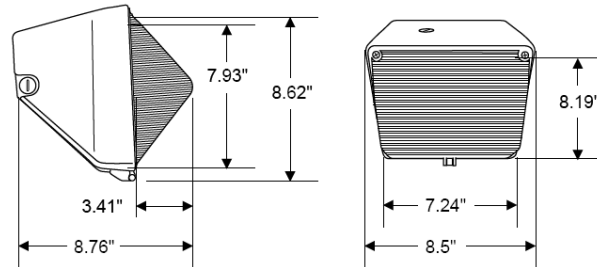

Fixture	Height	Width	Depth	MH	HPS	Weight
WP10	9"	8.5"	8.76"	100w	150w	9lbs.

Isolux Curves

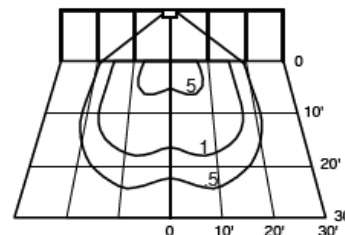

100w HPS
@ 10-Ft.
Mounting
Height

ORDERING INFORMATION:

Model	Optics	Wattage	Source	Voltage	Mounting	Finish	Options
<ul style="list-style-type: none"> WP10 	Polycarbonate Wide <ul style="list-style-type: none"> (PW) 	35w <ul style="list-style-type: none"> (35) 50w <ul style="list-style-type: none"> (50) 70w <ul style="list-style-type: none"> (70) 100w <ul style="list-style-type: none"> (100) Fluorescent 26w <ul style="list-style-type: none"> (26) 32w <ul style="list-style-type: none"> (32) 42w <ul style="list-style-type: none"> (42) 	High Pressure Sodium <ul style="list-style-type: none"> (HPS) Metal Halide <ul style="list-style-type: none"> (MH) CFL <ul style="list-style-type: none"> (FL) 	120 Volts <ul style="list-style-type: none"> (120) 208 Volts <ul style="list-style-type: none"> (208) 240 Volts <ul style="list-style-type: none"> (240) 277 Volts <ul style="list-style-type: none"> (277) Quad-Tap <ul style="list-style-type: none"> (QT) 	Wall Mount <ul style="list-style-type: none"> (WM) 	Bronze <ul style="list-style-type: none"> (BZ) White <ul style="list-style-type: none"> (WT) Custom Color <ul style="list-style-type: none"> (CC) Consult Factory	Photo Cell 120 - 277v <ul style="list-style-type: none"> (PC__)

Direct Lighting Sales reserves the right to make modifications or changes to any of its products without prior written notification and without incurring obligation. Actual performance can vary depending on surrounding conditions

WP12



SPECIFICATIONS:

Housing:

Die-Cast Aluminum housing with 1/2" threaded holes provided in two locations for surface conduit entry or optional photo cell. Door frame is Hinged for easy re-lamping complete with weather proof silicone seal.

Lens:

Clear prismatic borosilicate glass refractor is thermal and shock Resistant.

Reflector:

Hammered specular aluminum reflector for optimum light distribution.

Ballast Assembly:

HID Ballast constant Wattage Auto-Transformer High Power Factor Core And coil Type, Rated -20 Degrees Fahrenheit Staring Temperature. Integrally Mounted in the Luminaire and Completely Prewired. Each Ballast Assembly Is Thoroughly Tested Prior To Shipment. Ballast and Electrical Components Are "UL" Listed.

Lamp Socket:

Porcelain Socket pulse rated for HPS, MH & PS lamps. Lamp included.

Finish:

Electro-Static Powder Coat Bronze & White, contact factory for custom Colors.

Job Information

Project:	Date:
Location:	
Fixture Type:	Cat. #
Lamp:	Volts:
Options & Accessories:	

DIMENSIONAL DRAWINGS

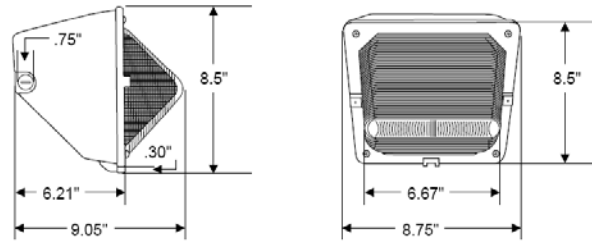

Fixture	Height	Width	Depth	MH	HPS	Weight
WP12	8.5"	8.75"	9.05"	100	150	10 lbs.

Isolux Curves

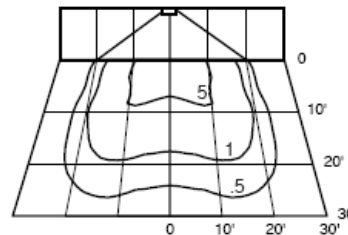

100w MH
@ 10-Ft.
Mounting
Height

ORDERING INFORMATION:

Model	Optics	Wattage	Source	Voltage	Mounting	Finish	Options
<ul style="list-style-type: none"> WP12 	Borosilicate Glass <ul style="list-style-type: none"> (BG) 	35w <ul style="list-style-type: none"> (35) 50w <ul style="list-style-type: none"> (50) 70w <ul style="list-style-type: none"> (70) 100w <ul style="list-style-type: none"> (100) 150w <ul style="list-style-type: none"> (150) 	High Pressure Sodium <ul style="list-style-type: none"> (HPS) Metal Halide <ul style="list-style-type: none"> (MH) 	120 Volts <ul style="list-style-type: none"> (120) 208 Volts <ul style="list-style-type: none"> (208) 240 Volts <ul style="list-style-type: none"> (240) 277 Volts <ul style="list-style-type: none"> (277) 480 Volts <ul style="list-style-type: none"> (480) Multi-Tap Ballast Factory wired at 277v unless otherwise specified.	Wall Mount <ul style="list-style-type: none"> (WM) 	Bronze <ul style="list-style-type: none"> (BZ) White <ul style="list-style-type: none"> (WT) Custom Color <ul style="list-style-type: none"> (CC) Consult Factory	Photo Cell 120 - 277v <ul style="list-style-type: none"> (PC__) Wire guard <ul style="list-style-type: none"> (WG)

Direct Lighting Sales reserves the right to make modifications or changes to any of its products without prior written notification and without incurring obligation. Actual performance can vary depending on surrounding conditions

WP13



SPECIFICATIONS:

Housing:

Die-Cast Aluminum housing with Threaded Conduit Access, optional Photo Cell

Lens:

Gasketed & Sealed Borosilicate Lens Glass

Reflector:

Specular aluminum reflector

Ballast Assembly:

HID Ballast constant Wattage Auto-Transformer High Power Factor Core and coil Type, Rated -20 Degrees Fahrenheit Staring Temperature. Integrally Mounted in the Luminaire and Completely Prewired. Each Ballast Assembly Is Thoroughly Tested Prior To Shipment. Ballast and Electrical Components Are "UL" Listed.

Lamp Socket:

Porcelain Socket pulse rated for HPS & MH lamps. Lamp included.

Finish:

Electro-Static Powder Coat Bronze & White

Job Information

Project:	Date:
Location:	
Fixture Type:	Cat. #
Lamp:	Volts:
Options & Accessories:	

DIMENSIONAL DRAWINGS

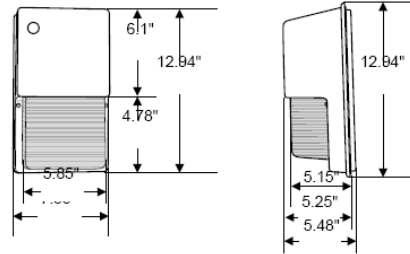

Fixture	Height	Width	Depth	MH	HPS	Weight
WP13	13"	7.85"	5.48"	50-100	50-100	13 lbs.

Isolux Curves

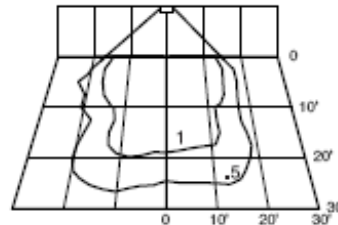

100w HPS @ 10-Ft. Mounting Height

ORDERING INFORMATION:

Model	Optics	Wattage	Source	Voltage	Wiring	Finish	Options
<ul style="list-style-type: none"> WP13 	Borosilicate Glass <ul style="list-style-type: none"> (BG) 	50w <ul style="list-style-type: none"> (50) 70w <ul style="list-style-type: none"> (70) 100w <ul style="list-style-type: none"> (100) 	High Pressure Sodium <ul style="list-style-type: none"> (HPS) Metal Halide <ul style="list-style-type: none"> (MH) Compact Fluorescent <ul style="list-style-type: none"> (CFL) Consult Factory	120 Volts <ul style="list-style-type: none"> (120) 208 Volts <ul style="list-style-type: none"> (208) 240 Volts <ul style="list-style-type: none"> (240) 277 Volts <ul style="list-style-type: none"> (277) Multi-tap ballast factory wired at 277v unless otherwise Specified.	Wall Mount <ul style="list-style-type: none"> (WM) 	Bronze <ul style="list-style-type: none"> (BZ) White <ul style="list-style-type: none"> (WT) 	Photo Cell 120 - 277v <ul style="list-style-type: none"> (PC __) Wire Guard <ul style="list-style-type: none"> (WG)

Direct Lighting Sales reserves the right to make modifications or changes to any of its products without prior written notification and without incurring obligation. Actual performance can vary depending on surrounding conditions

WP14



SPECIFICATIONS:

Housing:

Polycarbonate lens & housing with conduit access, optional photo cell. Door frame is gasketed to withstand the harshest environment

Lens:

Clear prismatic polycarbonate lens is thermal and shock Resistant.

Reflector:

Hammered specular aluminum reflector for optimum light distribution.

Ballast Assembly:

HID Ballast constant Wattage Auto-Transformer High Power Factor Core And coil Type, Rated -20 Degrees Fahrenheit Starting Temperature. Integrally Mounted in the Luminaire and Completely Prewired. Each Ballast Assembly Is Thoroughly Tested Prior To Shipment. Ballast and electrical components are "UL" listed.

Lamp Socket:

Porcelain Socket pulse rated for HPS, MH & PS lamps. Lamp included.

Finish:

Electro-Static Powder Coat Bronze & White, contact factory for custom Colors.

Job Information

Project:	Date:
Location:	
Fixture Type:	Cat. #
Lamp:	Volts:
Options & Accessories:	

DIMENSIONAL DRAWINGS

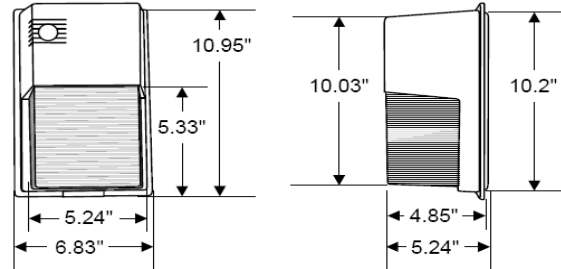

Fixture	Height	Width	Depth	CFL	HPS	Weight
WP14	10.95"	6.83"	5.24"	1x42w	70	6 lbs.

Isolux Curves

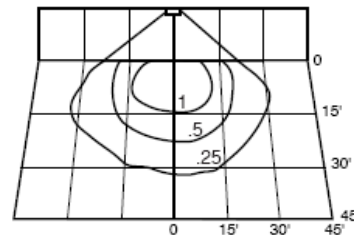

70W HPS
@ 15-Ft.
Mounting
Height

ORDERING INFORMATION:

Model	Optics	Wattage	Source	Voltage	Mounting	Finish	Options
<ul style="list-style-type: none"> WP-14 	Polycarbonate Wide <ul style="list-style-type: none"> (PW) 	HPS 35w <ul style="list-style-type: none"> (35) 50w <ul style="list-style-type: none"> (50) 70w <ul style="list-style-type: none"> (70) Fluorescent 1x26w <ul style="list-style-type: none"> (26) 1x32w <ul style="list-style-type: none"> (132) 1x42 <ul style="list-style-type: none"> (142) 2x13w <ul style="list-style-type: none"> (213) 	HPS <ul style="list-style-type: none"> (HPS) Fluorescent <ul style="list-style-type: none"> (FL) 	120 Volts <ul style="list-style-type: none"> (120) 208 Volts <ul style="list-style-type: none"> (208) 240 Volts <ul style="list-style-type: none"> (240) 277 Volts <ul style="list-style-type: none"> (277) 480 Volts <ul style="list-style-type: none"> (480) Multi-Tap Ballast Factory wired at 277v unless otherwise specified.	Wall Mount <ul style="list-style-type: none"> (WM) 	Bronze <ul style="list-style-type: none"> (BZ) Custom Color (CC) Consult Factory	Photo Cell 120 - 277v <ul style="list-style-type: none"> (PC__)

Direct Lighting Sales reserves the right to make modifications or changes to any of its products without prior written notification and without incurring obligation. Actual performance can vary depending on surrounding conditions

WP15



SPECIFICATIONS:

Housing:

Die-Cast Aluminum housing with 1/2" threaded holes provided in three locations for surface conduit entry or optional photo cell. Door frame is Hinged for easy re-lamping complete with weather proof silicone seal.

Lens:

Clear prismatic borosilicate glass refractor is thermal and shock Resistant.

Reflector:

Hammered specular aluminum reflector for optimum light distribution.

Ballast Assembly:

HID Ballast constant Wattage Auto-Transformer High Power Factor Core And coil Type, Rated -20 Degrees Fahrenheit Starting Temperature. Integrally Mounted in the Luminaire and Completely Prewired. Each Ballast Assembly Is Thoroughly Tested Prior To Shipment. Ballast and Electrical Components Are "UL" Listed.

Lamp Socket:

Porcelain Socket pulse rated for HPS, MH & PS lamps. Lamp included.

Finish:

Electro-Static Powder Coat Bronze & White, contact factory for custom Colors.

Job Information

Project:	Date:
Location:	
Fixture Type:	Cat. #
Lamp:	Volts:
Options & Accessories:	

DIMENSIONAL DRAWINGS

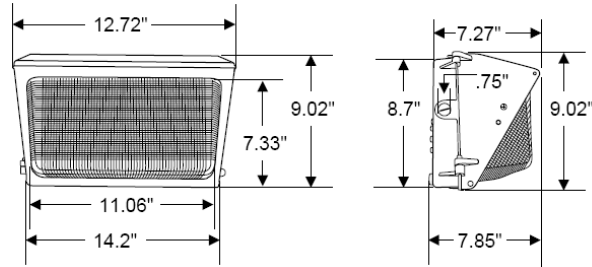

Fixture	Height	Width	Depth	MH	HPS	Weight
WP15	9.02"	12.72"	7.85"	175	150	18 lbs.

Isolux Curves

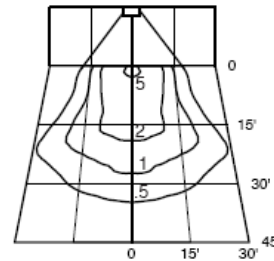

175w MH @ 15-Ft. Mounting Height

ORDERING INFORMATION:

Model	Optics	Wattage	Source	Voltage	Mounting	Finish	Options
<ul style="list-style-type: none"> WP15 	Borosilicate Glass <ul style="list-style-type: none"> (BG) 	70w <ul style="list-style-type: none"> (70) 100w <ul style="list-style-type: none"> (100) 150w <ul style="list-style-type: none"> (150) 175w <ul style="list-style-type: none"> (175) 2x42w <ul style="list-style-type: none"> (242) 	HPS <ul style="list-style-type: none"> (HPS) Metal Halide <ul style="list-style-type: none"> (MH) Compact Fluorescent <ul style="list-style-type: none"> (CF) 	120 Volts <ul style="list-style-type: none"> (120) 208 Volts <ul style="list-style-type: none"> (208) 240 Volts <ul style="list-style-type: none"> (240) 277 Volts <ul style="list-style-type: none"> (277) 480 Volts <ul style="list-style-type: none"> (480) Multi-Tap Ballast Factory wired at 277v unless otherwise specified.	Wall Mount <ul style="list-style-type: none"> (WM) 	Bronze <ul style="list-style-type: none"> (BZ) White <ul style="list-style-type: none"> (WT) Custom Color <ul style="list-style-type: none"> (CC) Consult Factory	Photo Cell 120 - 277v <ul style="list-style-type: none"> (PC__) Wire Guard <ul style="list-style-type: none"> (WG) Poly Guard <ul style="list-style-type: none"> (PG)

Direct Lighting Sales reserves the right to make modifications or changes to any of its products without prior written notification and without incurring obligation. Actual performance can vary depending on surrounding conditions

WP25



SPECIFICATIONS:

Housing:

Die-Cast Aluminum housing with 1/2" threaded holes provided in three locations for surface conduit entry or optional photo cell. Door frame is Hinged for easy re-lamping complete with weather proof silicone seal.

Lens:

Clear prismatic borosilicate glass refractor is thermal and shock Resistant.

Reflector:

Hammered specular aluminum reflector for optimum light distribution.

Ballast Assembly:

HID Ballast constant Wattage Auto-Transformer High Power Factor Core And coil Type, Rated -20 Degrees Fahrenheit Starting Temperature. Integrally Mounted in the Luminaire and Completely Prewired. Each Ballast Assembly Is Thoroughly Tested Prior To Shipment. Ballast and Electrical Components Are "UL" Listed.

Lamp Socket:

Porcelain Socket pulse rated for HPS, MH & PS lamps. Lamp included.

Finish:

Electro-Static Powder Coat Bronze & White, contact factory for custom Colors.

Job Information

Project:	Date:
Location:	
Fixture Type:	Cat. #
Lamp:	Volts:
Options & Accessories:	

DIMENSIONAL DRAWINGS

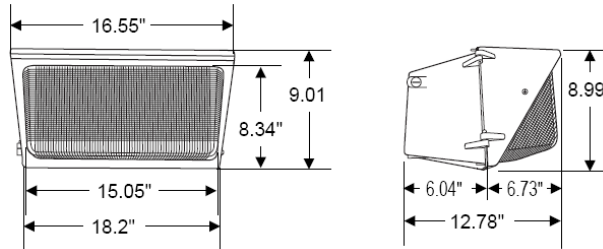

Height	Width	Depth	MH	PS	HPS	Weight
9.01"	18.2"	12.78"	400	400	400	32 lbs.

Isolux Curves

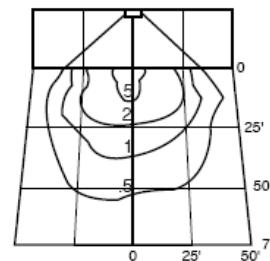

400w MH
@ 25-Ft.
Mounting
Height

ORDERING INFORMATION:

Model	Optics	Wattage	Source	Voltage	Wiring	Finish	Options
<ul style="list-style-type: none"> WP25 	Borosilicate Glass <ul style="list-style-type: none"> (BG) 	250w <ul style="list-style-type: none"> (250) 320w <ul style="list-style-type: none"> (320) 350w <ul style="list-style-type: none"> (350) 400w <ul style="list-style-type: none"> (400) 	High Pressure Sodium <ul style="list-style-type: none"> (HPS) Metal Halide <ul style="list-style-type: none"> (MH) Pulse Start Metal Halide <ul style="list-style-type: none"> (PS) 	120 Volts <ul style="list-style-type: none"> (120) 208 Volts <ul style="list-style-type: none"> (208) 240 Volts <ul style="list-style-type: none"> (240) 277 Volts <ul style="list-style-type: none"> (277) 480 Volts <ul style="list-style-type: none"> (480) Multi-Tap Ballast Factory wired at 277v unless otherwise specified.	Wall Mount <ul style="list-style-type: none"> (WM) 	Bronze <ul style="list-style-type: none"> (BZ) White <ul style="list-style-type: none"> (WT) Custom Color <ul style="list-style-type: none"> (CC) Consult Factory	Photo Cell 120 - 277v <ul style="list-style-type: none"> (PC__) Wire Guard <ul style="list-style-type: none"> (WG) Poly Guard <ul style="list-style-type: none"> (PG)

Direct Lighting Sales reserves the right to make modifications or changes to any of its products without prior written notification and without incurring obligation. Actual performance can vary depending on surrounding conditions

WP302



SPECIFICATIONS:

Housing:

Die-Cast Aluminum housing with Threaded Side Conduit Access, Photo-Cell, Full Cut off of Light Below The Horizon, Dark Sky Compliant Reduces Light Pollution, Hinged Face Frame.

Lens:

Clear Glass Lens, 1/8" Tempered, Gasket and Silicone Sealed

Reflector:

Specular aluminum reflector

Electrical Assembly:

HID ballast constant wattage auto-transformer high power factor core And coil type, rated -20 degrees Fahrenheit starting temperature. Integrally mounted in the luminaire and completely pre-wired. Each ballast Assembly is thoroughly tested prior to shipment. Ballast and electrical components are "UL" listed.

Lamp Socket:

Porcelain Socket pulse rated for HPS & MH lamps. Lamp included.

Finish:

Thermoset polyester powder coat finish, chemically pretreated through A multi-stage washer, oven baked at 400 degrees Fahrenheit to insure Maximum adherence.

Job Information

Project:	Date:
Location:	
Fixture Type:	Cat. #
Lamp:	Volts:
Options & Accessories:	

DIMENSIONAL DRAWINGS

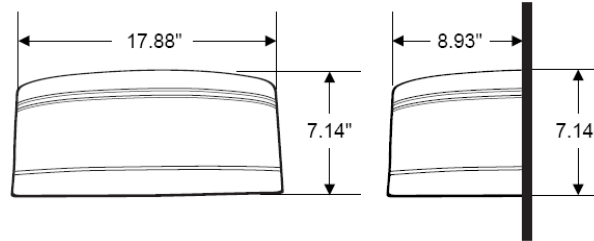

Height	Width	Depth	MH	PS	HPS	Weight
7.14"	17.88"	8.93"	35-175	—	50-150	22 lbs.

Isolux Curves

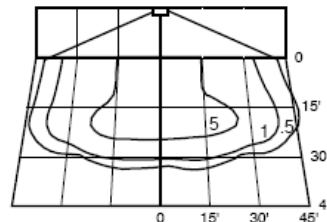

175w MH
@ 15-Ft.
Mounting
Height

ORDERING INFORMATION:

Model	Optics	Wattage	Source	Voltage	Mounting	Finish	Options
<ul style="list-style-type: none"> WP302 	Forward Throw Wide <ul style="list-style-type: none"> (FTW) 	35w <ul style="list-style-type: none"> (35) 50w <ul style="list-style-type: none"> (50) 70w <ul style="list-style-type: none"> (70) 100w <ul style="list-style-type: none"> (100) 150w <ul style="list-style-type: none"> (150) 175w <ul style="list-style-type: none"> (175) 	High Pressure Sodium <ul style="list-style-type: none"> (HPS) Metal Halide <ul style="list-style-type: none"> (MH) 	120 Volts <ul style="list-style-type: none"> (120) 208 Volts <ul style="list-style-type: none"> (208) 240 Volts <ul style="list-style-type: none"> (240) 277 Volts <ul style="list-style-type: none"> (277) 480 Volts <ul style="list-style-type: none"> (480) Multi-Tap Ballast Factory wired at 277v unless otherwise specified.	Wall Mount <ul style="list-style-type: none"> (WM) 	Bronze <ul style="list-style-type: none"> (BZ) White <ul style="list-style-type: none"> (WT) Custom Color <ul style="list-style-type: none"> (CC) Consult Factory	Photo Cell 120 - 277v <ul style="list-style-type: none"> (PC__)

Direct Lighting Sales reserves the right to make modifications or changes to any of its products without prior written notification and without incurring obligation. Actual performance can vary depending on surrounding conditions

WP303



SPECIFICATIONS:

Housing:

Die-Cast Aluminum housing, Compact Design, Hinged Face Frame, Full Cut Off, Reduces light Pollution, Dark Sky Compliant, Quick Install bracket for Proper Alignment.

Lens:

Tempered 1/8" glass lens, Gasket and Silicone Sealed

Reflector:

Segmented anodized specular aluminum reflector

Electrical Assembly:

HID ballast constant wattage auto-transformer high power factor core and coil type, rated -20 degrees Fahrenheit starting temperature. Integrally Mounted in the luminaire and completely prewired. Each ballast assembly is thoroughly tested prior to shipment. Ballast And Electrical Components are "UL" Listed.

Lamp Socket:

Porcelain Socket pulse rated for HPS & MH lamps. Lamp included.

Finish:

Thermoset polyester textured powder coat finish, chemically pretreated through a multi-stage washer, oven baked at 400 degrees Fahrenheit to insure maximum adherence.

Job Information

Project:	Date:
Location:	
Fixture Type:	Cat. #
Lamp:	Volts:
Options & Accessories:	

DIMENSIONAL DRAWINGS

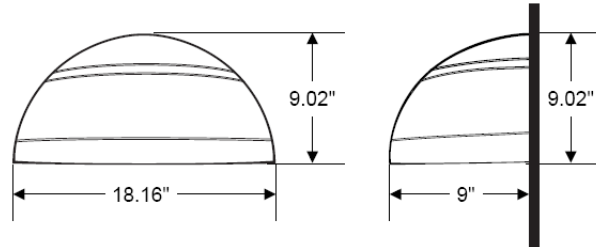

Height	Width	Depth	MH	PS	HPS	Weight
9.02"	18.16"	9"	70-175	70-175	70-150	20 lbs.

Isolux Curves

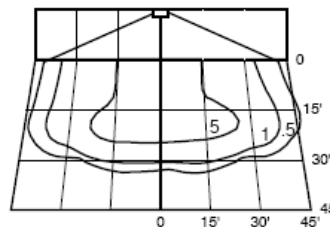

175w MH
@ 15-Ft.
Mounting
Height

ORDERING INFORMATION:

Model	Optics	Wattage	Source	Voltage	Mounting	Finish	Options
<ul style="list-style-type: none"> WP303 	Forward Throw Wide <ul style="list-style-type: none"> (FTW) 	35w <ul style="list-style-type: none"> (35) 50w <ul style="list-style-type: none"> (50) 70w <ul style="list-style-type: none"> (70) 100w <ul style="list-style-type: none"> (100) 150w <ul style="list-style-type: none"> (150) 175w <ul style="list-style-type: none"> (175) 26w <ul style="list-style-type: none"> (26) 32w <ul style="list-style-type: none"> (32) 42w <ul style="list-style-type: none"> (42) 	High Pressure Sodium <ul style="list-style-type: none"> (HPS) Metal Halide <ul style="list-style-type: none"> (MH) Pulse start Metal Halide <ul style="list-style-type: none"> (PS) Compact Fluorescent <ul style="list-style-type: none"> (CFL) 	120 Volts <ul style="list-style-type: none"> (120) 208 Volts <ul style="list-style-type: none"> (208) 240 Volts <ul style="list-style-type: none"> (240) 277 Volts <ul style="list-style-type: none"> (277) 480 Volts <ul style="list-style-type: none"> (480) Multi-Tap Ballast Factory wired at 277v unless otherwise specified.	Wall Mount <ul style="list-style-type: none"> (WM) 	Bronze <ul style="list-style-type: none"> (BZ) White <ul style="list-style-type: none"> (WT) Black <ul style="list-style-type: none"> (BK) Custom Color <ul style="list-style-type: none"> (CC) Consult Factory	Photo Cell 120 - 277v <ul style="list-style-type: none"> (PC__) Emergency Ballast <ul style="list-style-type: none"> (EB) Emergency Ballast Cold Weather <ul style="list-style-type: none"> (EBCW)

Direct Lighting Sales reserves the right to make modifications or changes to any of its products without prior written notification and without incurring obligation. Actual performance can vary depending on surrounding conditions

WPC15



SPECIFICATIONS:

Housing:

Die-Cast Aluminum housing with threaded holes provided for surface conduit entry or optional photo cell. Door frame is Hinged for easy re-lamping complete with weather proof silicone seal.

Lens:

Clear prismatic borosilicate glass refractor is thermal and shock resistant.

Reflector:

Hammered specular aluminum reflector for optimum light distribution.

Ballast Assembly:

HID Ballast constant Wattage Auto-Transformer High Power Factor Core And coil Type, Rated -20 Degrees Fahrenheit Starting Temperature. Integrally Mounted in the Luminaire and Completely Prewired. Each Ballast Assembly Is Thoroughly Tested Prior To Shipment. Ballast and Electrical Components Are "UL" Listed.

Lamp Socket:

Porcelain Socket pulse rated for HPS, MH & PS lamps. Lamp included.

Finish:

Electro-Static Powder Coat Bronze & White, contact factory for custom colors.

Job Information

Project: _____ Date: _____

Location: _____

Fixture Type: _____ Cat. # _____

Lamp: _____ Volts: _____

Options & Accessories: _____

DIMENSIONAL DRAWINGS

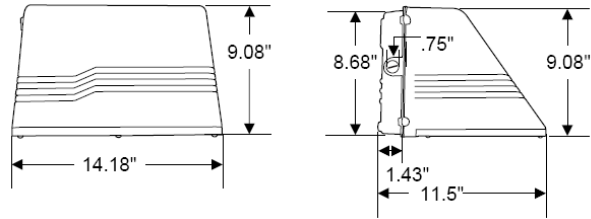

Height	Width	Depth	MH	CFL	HPS	Weight
9.08"	14.18"	11.50"	70-175	1x26-2x42	35-150	19 lbs.

Isolux Curves

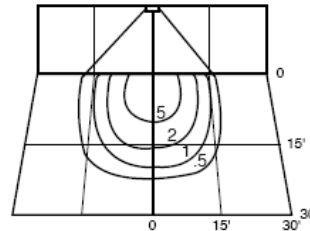

175w MH
@ 15-Ft.
Mounting
Height

ORDERING INFORMATION:

Model	Optics	Wattage	Source	Voltage	Mounting	Finish	Options
<ul style="list-style-type: none"> WPC15 	Forward Throw Wide <ul style="list-style-type: none"> (FTW) 	<ul style="list-style-type: none"> (35) 35w (70) 70w (100) 100w (150) 150w (175) 175w Compact Fluorescent 1x26w (126) 1x32w (132) 1x42w (142) 2x26w (226) 2x32w (232) 2x42w (242) 	High Pressure Sodium <ul style="list-style-type: none"> (HPS) Metal Halide <ul style="list-style-type: none"> (MH) Compact Fluorescent <ul style="list-style-type: none"> (CFL) 	120 Volts <ul style="list-style-type: none"> (120) 208 Volts <ul style="list-style-type: none"> (208) 240 Volts <ul style="list-style-type: none"> (240) 277 Volts <ul style="list-style-type: none"> (277) 480 Volts <ul style="list-style-type: none"> (480) Multi-Tap Ballast Factory wired at 277v unless otherwise specified.	Wall Mount <ul style="list-style-type: none"> (WM) 	Bronze <ul style="list-style-type: none"> (BZ) White <ul style="list-style-type: none"> (WT) Custom Color <ul style="list-style-type: none"> (CC) 	Photo Cell 120 - 480v <ul style="list-style-type: none"> (PC __)

Direct Lighting Sales reserves the right to make modifications or changes to any of its products without prior written notification and without incurring obligation. Actual performance can vary depending on surrounding conditions

WPC25



SPECIFICATIONS:

Housing:

Die-Cast Aluminum housing with threaded holes provided for surface conduit entry or optional photo cell. Door frame is Hinged for easy re-lamping complete with weather proof silicone seal.

Lens:

Clear 1/8" thick tempered glass refractor is thermal and shock Resistant.

Reflector:

Hammered specular aluminum reflector for optimum light distribution.

Electrical Assembly:

HID Ballast constant Wattage Auto-Transformer High Power Factor Core And coil Type, Rated -20 Degrees Fahrenheit Staring Temperature. Integrally Mounted in the Luminaire and Completely Prewired. Each Ballast Assembly Is Thoroughly Tested Prior To Shipment. Ballast and electrical components are "UL" listed

Lamp Socket:

Porcelain Socket pulse rated for HPS, MH & PS lamps. Lamp included.

Finish:

Electro-Static Powder Coat Bronze, White & black contact factory for custom Colors.

Job Information

Project:	Date:
Location:	
Fixture Type:	Cat. #
Lamp:	Volts:
Options & Accessories:	

DIMENSIONAL DRAWINGS

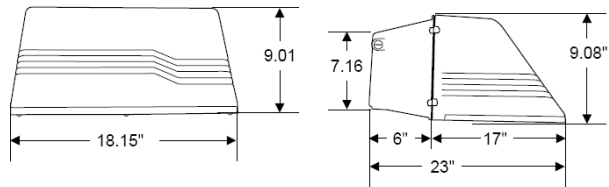

Height	Width	Depth	MH	PS	HPS	Weight
9.08"	18.15"	23"	250-400	250-400	250-400	28 lbs.

Isolux Curves

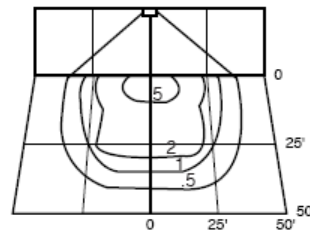

400w MH
@ 25-Ft.
Mounting
Height

ORDERING INFORMATION:

Model	Optics	Wattage	Source	Voltage	Mounting	Finish	Options
<ul style="list-style-type: none"> WCP25 	Forward Throw Wide <ul style="list-style-type: none"> (FTW) 	100w <ul style="list-style-type: none"> (100) 150w <ul style="list-style-type: none"> (150) 250w <ul style="list-style-type: none"> (250) 320w <ul style="list-style-type: none"> (320) 350w <ul style="list-style-type: none"> (350) 400w <ul style="list-style-type: none"> (400) 	High Pressure Sodium <ul style="list-style-type: none"> (HPS) Metal Halide <ul style="list-style-type: none"> (MH) Pulse Start Metal Halide <ul style="list-style-type: none"> (PS) 	120 Volts <ul style="list-style-type: none"> (120) 208 Volts <ul style="list-style-type: none"> (208) 240 Volts <ul style="list-style-type: none"> (240) 277 Volts <ul style="list-style-type: none"> (277) 480 Volts <ul style="list-style-type: none"> (480) Multi-Tap Ballast Factory wired at 277v unless otherwise specified.	Wall Mount <ul style="list-style-type: none"> (WM) 	Bronze <ul style="list-style-type: none"> (BZ) White <ul style="list-style-type: none"> (WT) Custom Color <ul style="list-style-type: none"> (CC) Consult Factory	Photo Cell <ul style="list-style-type: none"> (PC__) <ul style="list-style-type: none"> 120 - 277v (PC__)

Direct Lighting Sales reserves the right to make modifications or changes to any of its products without prior written notification and without incurring obligation. Actual performance can vary depending on surrounding conditions

WPR40



SPECIFICATIONS:

Housing:

Die-cast aluminum door has four captive stainless steel fasteners and can be removed from the die-cast aluminum housing. Provided with (4) .50" coin plugs for surface conduit run.

Lens:

Heat and shock resistant borosilicate glass. Available in clear or frosted white, both with radial prisms to provide superior illumination

Reflector:

specular white aluminum reflector .

Ballast Assembly:

HID ballast constant wattage auto-transformer high power factor core and coil type, rated -20 degrees Fahrenheit starting temperature. Integrally Mounted in the luminaire and completely prewired. Each ballast assembly is thoroughly tested prior to shipment. Ballast And Electrical Components are "UL" Listed.

Lamp Socket:

Porcelain socket pulse rated for HPS & MH lamps. lamp included.

Finish:

Attractive dark bronze, white, black polyester powder coated finish for excellent impact, corrosion and UV resistance

Job Information

Project:	Date:
Location:	
Fixture Type:	Cat. #
Lamp:	Volts:
Options & Accessories:	

DIMENSIONAL DRAWINGS

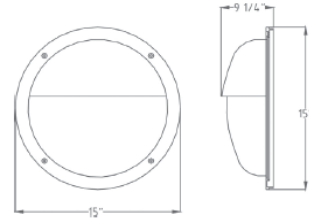

Height	Width	Depth	MH	HPS	EPA	Weight
15"	15"	9.25"	175	150	—	—

Optional Features



ORDERING INFORMATION:

Model	Optics	Wattage	Source	Voltage	Face	Finish	Options
<ul style="list-style-type: none"> WPC40 	Forward Throw Wide <ul style="list-style-type: none"> (FTW) Type V <ul style="list-style-type: none"> (T5) 	50w <ul style="list-style-type: none"> (50) 70w <ul style="list-style-type: none"> (70) 100w <ul style="list-style-type: none"> (100) 175w <ul style="list-style-type: none"> (175) Compact Fluorescent <ul style="list-style-type: none"> (CFL) Consult Facotry	High Pressure Sodium <ul style="list-style-type: none"> (HPS) Metal Halide <ul style="list-style-type: none"> (MH) Compact Fluorescent <ul style="list-style-type: none"> (CF) 	120 Volts <ul style="list-style-type: none"> (120) 208 Volts <ul style="list-style-type: none"> (208) 240 Volts <ul style="list-style-type: none"> (240) 277 Volts <ul style="list-style-type: none"> (277) 480 Volts <ul style="list-style-type: none"> (480) Multi-Tap Ballast Factory wired at 277v unless otherwise specified.	Open <ul style="list-style-type: none"> (O) Grid <ul style="list-style-type: none"> (G) Lid <ul style="list-style-type: none"> (L) 	Bronze <ul style="list-style-type: none"> (BZ) White <ul style="list-style-type: none"> (WT) Black <ul style="list-style-type: none"> (BK) Custom Color <ul style="list-style-type: none"> (CC) Consult Factory	Qtz Re-strike <ul style="list-style-type: none"> (QR) E. Ballast <ul style="list-style-type: none"> (EB) Single Fuse <ul style="list-style-type: none"> (SF) Double fuse <ul style="list-style-type: none"> (DF) Photocell 120 Thru 277 <ul style="list-style-type: none"> (PC__)

Direct Lighting Sales reserves the right to make modifications or changes to any of its products without prior written notification and without incurring obligation. Actual performance can vary depending on surrounding conditions

WPS40



SPECIFICATIONS:

Housing:

Die-Cast Aluminum housing with 1/2" threaded holes provided in two locations for surface conduit entry or optional photo cell. Door frame is Hinged for easy re-lamping complete with weather proof silicone seal.

Lens:

Clear prismatic borosilicate glass refractor is thermal and shock Resistant.

Reflector:

Hammered specular aluminum reflector for optimum light distribution.

Ballast Assembly:

HID Ballast constant Wattage Auto-Transformer High Power Factor Core And coil Type, Rated -20 Degrees Fahrenheit Staring Temperature. Integrally Mounted in the Luminaire and Completely Prewired. Each Ballast Assembly Is Thoroughly Tested Prior To Shipment. Ballast and electrical components are "UL" listed.

Lamp Socket:

Porcelain Socket pulse rated for HPS, MH & PS lamps. Lamp included.

Finish:

Electro-Static Powder Coat Bronze & White, contact factory for custom Colors.

Job Information

Project:	Date:
Location:	
Fixture Type:	Cat. #
Lamp:	Volts:
Options & Accessories:	

DIMENSIONAL DRAWINGS

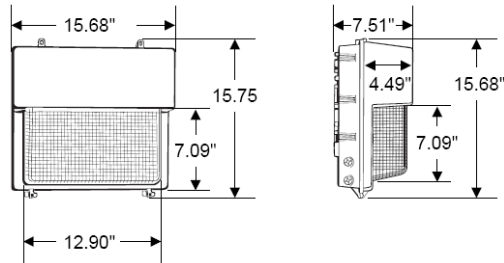

Height	Width	Depth	MH	PS	HPS	Weight
15.75"	12.90"	7.51"	250-400	320-400	250-400	29 lbs.

Isolux Curves

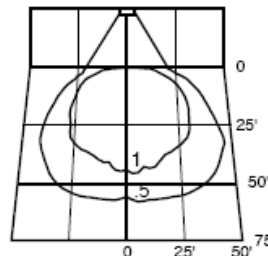

400w MH
@ 25-Ft.
Mounting
Height

ORDERING INFORMATION:

Model	Optics	Wattage	Source	Voltage	Mounting	Finish	Options
<ul style="list-style-type: none"> WPS40 	Forward Throw Wide <ul style="list-style-type: none"> (FTW) 	100w <ul style="list-style-type: none"> (100) 150w <ul style="list-style-type: none"> (150) 175w <ul style="list-style-type: none"> (175) 250w <ul style="list-style-type: none"> (250) 320w <ul style="list-style-type: none"> (320) 400w <ul style="list-style-type: none"> (400) 	High Pressure Sodium <ul style="list-style-type: none"> (HPS) Metal Halide <ul style="list-style-type: none"> (MH) Metal Halide Pulse Start <ul style="list-style-type: none"> (PS) 	120 Volts <ul style="list-style-type: none"> (120) 208 Volts <ul style="list-style-type: none"> (208) 240 Volts <ul style="list-style-type: none"> (240) 277 Volts <ul style="list-style-type: none"> (277) 480 Volts <ul style="list-style-type: none"> (480) Multi-Tap Ballast Factory wired at 277v unless otherwise specified.	Wall Mount <ul style="list-style-type: none"> (WM) 	Bronze <ul style="list-style-type: none"> (BZ) White <ul style="list-style-type: none"> (WT) Custom Color <ul style="list-style-type: none"> (CC) Consult Factory	Photo Cell 120 - 277v <ul style="list-style-type: none"> (PC__)

Direct Lighting Sales reserves the right to make modifications or changes to any of its products without prior written notification and without incurring obligation. Actual performance can vary depending on surrounding conditions